



Pipe connecting technology
Press tools & Accessories

novopress
because quality matters

Quality ensures your success

Latest technology for press tools

because quality matters - this principle serves as a guideline for us in our daily work. Since the company was founded in 1969, one of the most important guiding principles at Novopress has been the development and production of the highest quality products, along with quick, simple handling, long operating life and economic benefits.

As the first manufacturer of press tools, Novopress did pioneering work in the field of pipe connecting technology.

We have target solutions for your special requirements. Our highly skilled research and development team works constantly on practical and innovative solutions, which promise advanced technology 'Made in Germany'.

Good service is reflected in customer satisfaction. Let yourself be convinced by our wide product range and the extensive service package, which Novopress offers.



Best results by full service solution

- Consulting, development, final assembly, quality management and after-sales service from a single source.
- Close cooperation with long-standing suppliers for single component manufacturing.

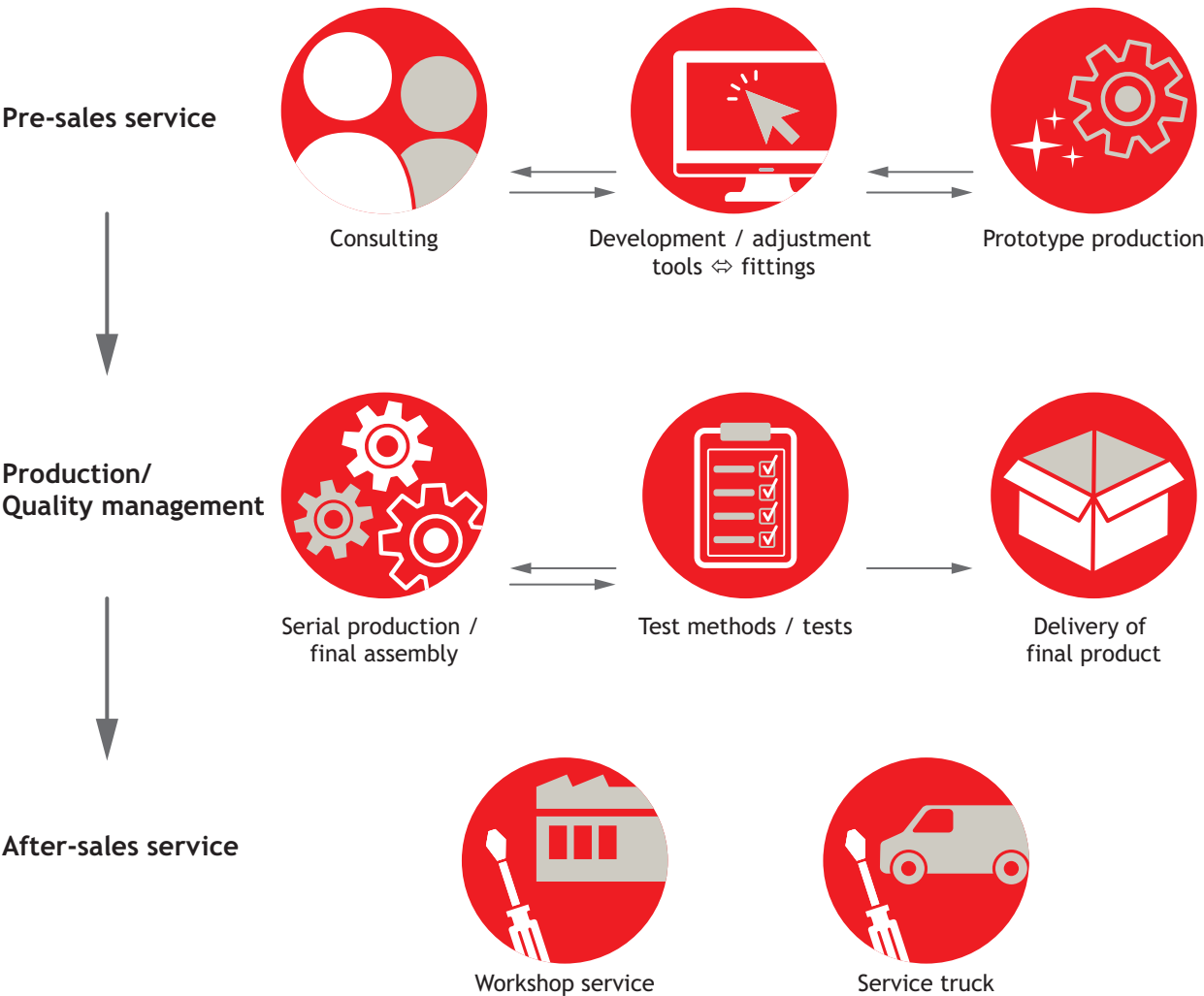

Development expertise in pre-sales service

Efficient processes for specific solutions

Novopress has a high level of development expertise for customized or even special solutions. Many years of experience in conceptual product development and in advanced manufacturing processes ensure the creation of high quality press tools and accessories. Not only single components and applications are to be considered, but even the whole system, in order to ensure best results in the field of joining technology.

During development we work closely together with our partners in order to achieve innovative results and high quality products. Thereby, the continuously grown know-how helps to make optimum use of resources and to create efficient development processes.

Extensive test methods and even a long proven test procedure ensure the high quality and the long operating life that we demand from our products. The basis for new tool generations are the customers' requirements just as our own ambitions to develop innovative and user-friendly products.



Adjustment of customized tools to the respective fitting

- Recording geometric data for fitting and pipe systems
- Adjustment of toolings to the outer fitting contour and to the requested pressing result
- Determination of the necessary press energies for the press system
- Considering used materials and their characteristic temperature reaction

The result: Reliable press results and safety for the complete press system.

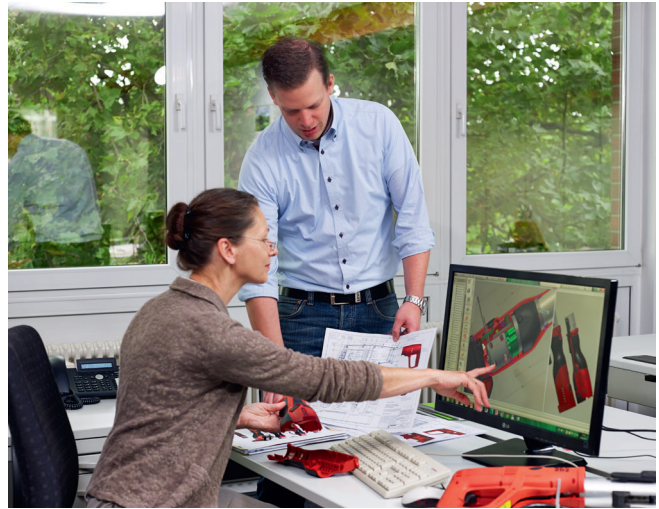

Tooling construction

- High operating life time due to FEA analysis during development
- Endurance tests in order to confirm the right tool construction
- Field tests in order to check handling and ergonomics
- Functional tests under different climatic conditions for the simulation of various geographic areas of application

For high quality and long-lasting products.

Certificates

All our developed press tools are certified internally and even externally by a third party.



Novopress' press tools

Novopress pressing units and accessories are suitable for a wide range of applications whether pipe and fittings are stainless steel, carbon steel, copper or plastic and offer you a secure solution in the area of pipe connecting technology:

Novopress tool features*:

- Fully automatic pressing cycle
- Log book
- Battery-empty-detection
- Illumination of the press area
- App integration

Pressing technology gets smart NovoCheck-App

We work continuously on the development of new practice-oriented and up-to-date extensions of our product range. For example, the press tools of our latest generation are equipped with Bluetooth® technology in order to offer an even wider range of service functionalities:

- Data transfer between pressing unit and app
- Ability to check the pressing unit's current status
- Analysis of the press tools' log book
- Integrated report function for documentation of the installation
- To be used with Novopress press tools of the latest generation: ACO103, ACO203, ACO203XL and ACO403

* For more information please see the respective detailed product information.



Pressing units



ACO103



Pressing range: up to 35 mm metal
up to 40 mm plastics

Product details on page 8
Suitable accessories on page 25



ACO203



Pressing range: up to 54 mm M-Contour
up to 108 mm V-Contour
up to 110 mm plastics

Product details on page 10
Suitable accessories from page 25

ECO203

Pressing range: up to 54 mm M-Contour
up to 108 mm V-Contour
up to 110 mm plastics

Product details on page 12

Suitable accessories from page 25



EFP203

Pressing range: up to 54 mm M-Contour
up to 108 mm V-Contour
up to 110 mm plastics

Product details on page 14

Suitable accessories from page 25



ACO203XL



Pressing range: up to 108 mm metal
up to 110 mm plastics

Product details on page 16
Suitable accessories from page 25



ACO403



Pressing range: 168.3 mm metal

Product details on page 18
Suitable accessories on page 26

Axial pressing units



AXI103



Pressing range: up to 40 mm plastics

Product details on page 20



AAP103



Pressing range: up to 40 mm plastics

Product details on page 22

Pressing unit ACO103



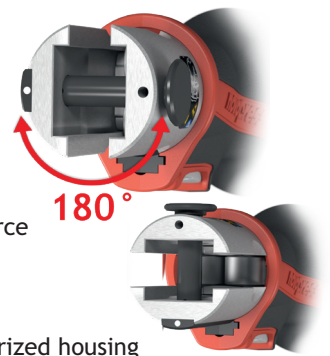

Compact and high-performance efficiency

- With rotatable head
- Powerful Milwaukee® Lithium-Ion batteries for reliable performance
- Redundant switch-off and press force control with LED indication
- Automatic pressing cycle
- Safe handling with slipproof rubberized housing and ergonomic design
- Illumination of the press area for safe working
- Analysis of the pressing unit's performance via NovoCheck app



 Metal up to 35 mm
Plastic up to 40 mm

 One-Hand-Operation

 Rotatable head

 Illumination of the press area

 Data transfer via Bluetooth®



Please find more information about our NovoCheck app on page 6.



Scope of application

- Drinking water-, gas- and heating installations, industry and commercial applications and many more
- Suitable for all authorized jaws of other system manufacturers in the market¹
- All common profiles for metal and plastic systems available



Accessories

- Press jaws PB1
- Pivoting rings with adaptor jaw SZB101
- Charger available in many worldwide power supply specifications
- Batteries with different capacities available



Press jaw PB1



The LED signal located under the transparent start button gives information about the battery and the status of the pressing unit or occurred failures.

Technical Data ACO103

Dimensions ² :	Metal pipe up to 35 mm / Plastic pipe up to 40 mm
Weight without battery:	1.6 kg
Length:	320 mm
Width:	98 mm
Height:	72 mm
Power consumption:	240 W
Piston force:	19 kN
Piston stroke:	30 mm
Battery:	Milwaukee® M12™ battery system ³
Battery capacity ⁴ :	up to 250 pressing cycles
Charging time ⁵ :	45 - 75 min.

1 for binding information please request your system manufacturer
 2 system-dependant
 3 all Milwaukee® capacities in the market can be used
 4 depending on material, dimension and battery capacity
 5 depending on battery capacity



Pressing unit ACO203

powered by Brushless Motor Technology

Fit for the future with the new tool generation

- Light-weight and handy
- Up to 40 % more pressings per battery charge¹
- Illumination of the press area for safe working
- Reduced need for maintenance due to new motor technology
- Maintenance interval of two years - without limited numbers of pressing cycles
- Analysis of the pressing unit's performance via NovoCheck app

- 

Metal	up to 54 mm (M-Contour)
	up to 108 mm (V-Contour)
Plastic	up to 110 mm
- 

Low weight

- 

Small tool dimensions

- 

Illumination of the press area

- 

Data transfer via Bluetooth®



Please find more information about our NovoCheck app on page 6.



Scope of application

- Drinking water-, gas- and heating installations, industry and commercial applications and many more
- Suitable for all authorized jaws of other system manufacturers in the market²
- All common profiles for metal and plastic systems available



Accessories

- Press jaws PB2
- Press collars with adaptor jaw ZB202 / ZB203
- Pivoting rings with adaptor jaw SZB201
- Charger available in many worldwide power supply specifications
- Batteries with different capacities and implemented battery-status-indication available

Compatible press jaws and collars



The implemented illumination of the press area makes working, even in difficult lighting conditions, easier.

Technical Data ACO203

Dimensions:	Metal pipe up to 54 mm (M-Contour), resp. up to 108 mm (V-Contour) / Plastic pipe up to 110 mm
Weight without battery:	2.3 kg
Length:	387 mm
Width:	75 mm
Height:	111 mm
Power consumption:	450 W
Piston force:	32 kN
Piston stroke:	40 mm
Battery:	Milwaukee® M18™ battery system ³
Battery capacity ⁴ :	up to 250 pressing cycles
Charging time ⁵ :	45 - 75 min.

1 in comparison to its predecessor ACO202

2 for binding information please request your system manufacturer

3 all Milwaukee® capacities in the market can be used

4 depending on material, dimension and battery capacity

5 depending on battery capacity



Pressing unit ECO203

Press technology of a new generation

- Only 3.2 kg (approx. 20 % savings in weight¹)
- More ergonomic thanks to smaller handle diameter
- Illumination of the press area for safe working
- Maintenance interval of two years - without limited numbers of pressing cycles



Metal up to 54 mm (M-Contour)
up to 108 mm (V-Contour)
Plastic up to 110 mm



Low weight



Compact tool dimensions



Illumination of the press area



Scope of application

- Drinking water-, gas- and heating installations, industry and commercial applications and many more
- Suitable for all authorized jaws of other system manufacturers in the market²
- All common profiles for metal and plastic systems available



Accessories

- Press jaws PB2
- Press collars with adaptor jaw ZB202 / ZB203
- Pivoting rings with adaptor jaw SZB201
- Available for many worldwide common power supplies



The implemented illumination of the press area makes working, even in difficult lighting conditions, easier.

Technical Data ECO203





Dimensions:	Metal pipe up to 54 mm (M-Contour), resp. up to 108 mm (V-Contour) / Plastic pipe up to 110 mm
Weight:	3.2 kg
Length:	397 mm
Width:	75 mm
Height:	113 mm
Power consumption:	450 W
Piston force:	32 kN
Piston stroke:	40 mm

1 in comparison to its predecessor ECO202
 2 for binding information please request your system manufacturer

Pressing unit EFP203

High performance
combined with slim design

- Lightweight and handy due to compact dimensions
- Robust design
- Automatic return
- Easy handling
- Rotatable head

-  Metal up to 54 mm (M-Contour)
Plastic up to 108 mm (V-Contour)
up to 110 mm
-  Low weight
-  Compact tool dimensions
-  Rotatable head



Scope of application

- Drinking water-, gas- and heating installations, industry and commercial applications and many more
- Suitable for all authorized jaws of other system manufacturers in the market¹
- All common profiles for metal and plastic systems available



Accessories

- Press jaws PB2
- Press collars with adaptor jaw ZB202 / ZB203
- Pivoting rings with adaptor jaw SZB201
- Available for many worldwide common power supplies



Press jaws and press collars



The manual release button allows a discharge of the jaw if necessary.

Technical Data EFP203

Dimensions:	Metal pipe up to 54 mm (M-Contour), resp. up to 108 mm (V-Contour) / Plastic pipe up to 110 mm
Weight:	3.0 kg
Length:	395 mm
Width:	81 mm
Height:	203 mm
Power consumption:	450 W
Piston force:	32 kN
Piston stroke:	40 mm

¹ for binding information please request your system manufacturer

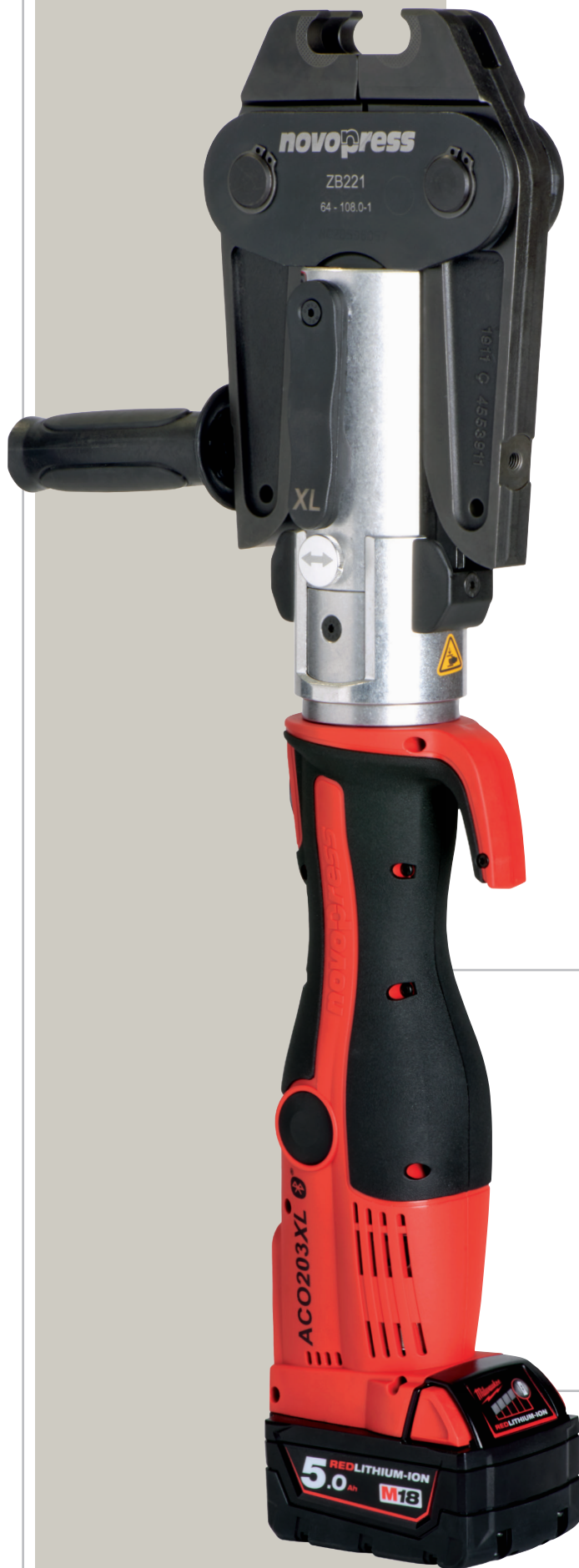

Pressing unit ACO203XL

powered by Brushless Motor Technology

The all-round talent even for big dimensions up to 108 mm

- Light-weight and handy
- 12 -108 mm with only one tool (all materials)
- Up to 40 % more pressings per battery charge¹
- Rotatable head
- Back stroke limitation - faster pressings with compatible jaws by an adaptable piston stroke
- Reduced need for maintenance due to new motor technology
- Analysis of the pressing unit's performance via NovoCheck app



Metal up to 108 mm
Plastic up to 110 mm



Up to 40 % more pressings
per battery charge¹



Status indication
with LED display



Rotatable head



Data transfer
via Bluetooth®



Please find more information about our NovoCheck app on page 6.



Scope of application

- Drinking water-, gas- and heating installations, industry and commercial applications and many more
- Suitable for all authorized jaws of other system manufacturers in the market²
- All common profiles for metal and plastic systems available



Accessories

- Press jaws PB2
- Press collars with adaptor jaws ZB202 / ZB203 / ZB221 / ZB222
- Pivoting rings with adaptor jaw SZB201
- Charger available in many worldwide power supply specifications
- Batteries with different capacities and implemented battery-status-indication available

Adaptor jaws ZB221 and ZB222



The finger protection as well as the manual bolt retention and the visual error indication, which is implemented in the start button, provide the necessary safety while working.

Technical Data ACO203XL

Dimensions:	Metal pipe up to 108 mm / Plastic pipe up to 110 mm
Weight without battery:	3.2 kg
Length:	460 mm
Width:	83 mm
Height:	113 mm
Power consumption:	450 W
Piston force:	32 kN
Piston stroke:	80 mm (optionally 40 mm)
Battery:	Milwaukee® M18™ battery system ³
Battery capacity ⁴ :	up to 250 pressing cycles
Charging time ⁵ :	45 - 75 min.

1 in comparison to its predecessor ACO202XL

2 for binding information please request your system manufacturer

3 all Milwaukee® capacities in the market can be used

4 depending on material, dimension, stroke adjustment and battery capacity

5 depending on battery capacity



Pressing unit ACO403

powered by Brushless Motor Technology

Highly Efficient Powerhouse

- High press force - powerful for large pipe dimensions
- Ideally suitable for special applications with special requirements concerning high pressure
- Battery status indicator - Battery capacity can be controlled anytime
- Analysis of the pressing unit's performance via NovoCheck app



Metal up to 168.3 mm



Rechargeable battery



Rotatable head



Data transfer
via Bluetooth®



Please find more information about our
NovoCheck app on page 6.



Scope of application

- Drinking water installations and high-pressure applications (such as sprinkler systems)
- Press collars for M-profile fittings of various system manufacturers available¹



Accessories

- Press collars 403
- Charger available in many worldwide power supply specifications
- Milwaukee® M18™ battery system with implemented battery-status-indication available



Strong connection
in a short time.



Press collar 403

Technical Data ACO403

Dimensions:	Metal pipe 76.1 / 88.9 / 108.0 / 114.0 / 139.7 / 168.3 mm, further on request
Weight without battery:	12.8 kg
Length:	650 mm
Width:	95 mm
Height:	320 mm
Power consumption:	450 W
Piston force:	120 kN
Piston stroke:	60 mm
Battery:	Milwaukee® M18™ battery system ²
Battery capacity ³ :	up to 30 pressing cycles
Charging time ⁴ :	45 - 75 min.

1 for binding information please request your system manufacturer
 2 all Milwaukee® capacities in the market can be used
 3 depending on material, dimension and battery capacity
 4 depending on battery capacity

Expander AXI103



Compact technology for exact expansion

- Compact design – 50 mm shorter and approx. 300 g lighter¹
- Safe handling due to ergonomic design and slip-proof rubberized housing
- Additional lateral warning LED for error messages
- Device suspension for carabiner or strap
- Powerful Milwaukee® M12™ Lithium-Ion batteries for reliable performance



Plastic systems up to 40 mm



One-Hand-Operation



Rechargeable battery



Illumination of the
press area



Prepared for
Bluetooth®



Scope of application

- Drinking water-, gas- and heating installation, industry and commercial application and many more
- Applicable in combination with the axial pressing unit AAP102 - suitable for many authorized plastic systems¹



Accessories

- Charger available in many worldwide power supply specifications
- Batteries with different capacities available

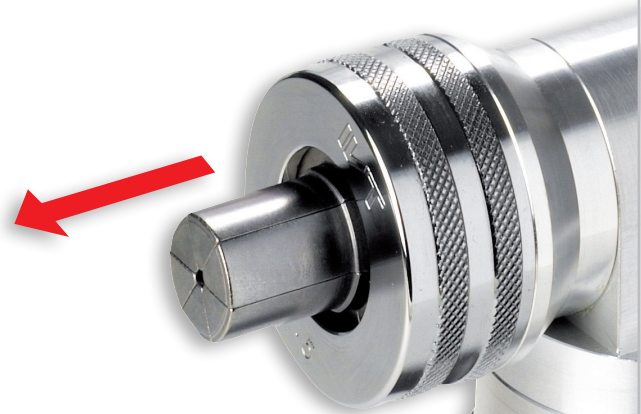

By actuating the start button the expanding cone drives forward and moves the segments of the expander head apart.

Technical Data AXI103

Dimensions*:	up to 40 mm
Weight without battery:	1.8 kg
Length:	273 mm
Width:	69 mm
Height:	119 mm
Power consumption:	240 W
Piston force:	system-dependant
Piston stroke:	system-dependant
Battery:	Milwaukee® M12™ battery system ²
Battery capacity ³ :	up to 180 expanding cycles
Charging time ⁴ :	45 - 75 min.

¹ in comparison to its predecessor AXI102

² system-dependant

³ all Milwaukee® capacities in the market can be used

⁴ depending on material, dimension and battery capacity

⁵ depending on battery capacity

Axial pressing unit AAP103



New compactness for axial pressing technology

- Compact design – 50 mm shorter and approx. 300 g lighter¹
- Safe handling due to ergonomic design and slip-proof rubberized housing
- Additional lateral warning LED for error messages
- Device suspension for carabiner or strap
- Powerful Milwaukee® M12™ Lithium-Ion batteries for reliable performance



Plastic systems up to 40 mm



One-Hand-Operation



Rechargeable battery



Illumination of the press area



Prepared for Bluetooth®



Scope of application

- Drinking water-, gas- and heating installations, industry and commercial applications and many more
- Pressfitting joints available for many authorized plastic systems²



Accessories

- Pressfitting joints² available in different dimensions
- Charger available in many worldwide power supply specifications
- Batteries with different capacities available

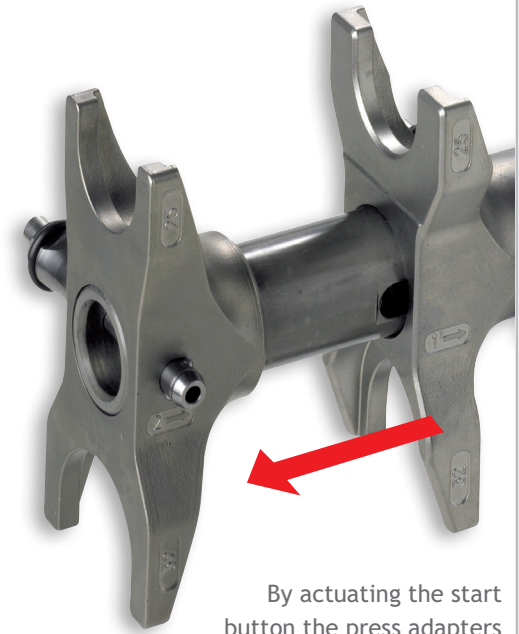

By actuating the start button the press adapters drive together.

Technical Data AAP103

Dimensions ² :	up to 40 mm
Weight without battery:	2.0 kg
Length:	275 mm
Width:	73 mm
Height:	195 mm
Power consumption:	240 W
Piston force:	system-dependant
Piston stroke:	system-dependant
Battery:	Milwaukee® M12™ battery system ³
Battery capacity ⁴ :	up to 180 pressing cycles
Charging time ⁴ :	45 - 75 min.

1 in comparison to its predecessor AAP102

2 system-dependant

3 all Milwaukee® capacities in the market can be used

4 depending on material, dimension and battery capacity

5 depending on battery capacity

Accessories

Press jaws & press collars

Reliable press results in all dimensions

- Versatilely applicable for dimension
12 up to 168.3 mm
- Applicable for metal and plastic systems
- User-friendly, lightweight and safe
- Thanks to spring force, the collar attaches itself
independently on the fitting



 Metal up to 168.3 mm
Plastic up to 110 mm

 Easy handling due to
“snap on” principle

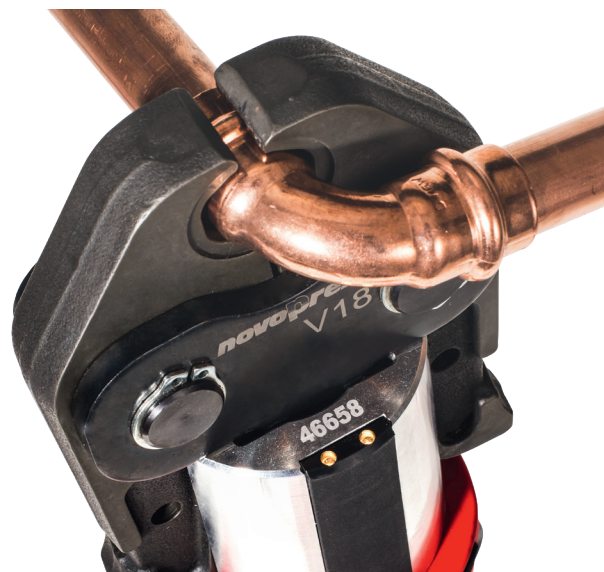

With their low weight and compact design, the press jaws form an ideal unit with the press tool and are optimally matched to the respective connection systems.

Press jaws

Press jaws PB1

- Suitable for ACO103
- Metal pipe systems: 12 - 35 mm
- Plastic pipe systems: 14 - 40 mm



Press jaws PB2

- Suitable for ACO203, ECO203, EFP203, ACO203XL
- Metal pipe systems: 12 - 54 mm
- Plastic pipe systems: 16 - 50 mm



Sliding jaw

Sliding jaw SB203, SB204

- Suitable for ACO203, ECO203, EFP203, ACO203XL
- SB204: 14 - 40 mm
- SB203: 40 - 63 mm



Accessories



The snap-on principle ensures that our press collars hold their position thanks to spring force on their own.

As a result Novopress press collars do not need any closure up to dimension 88.9 and are easier to use and less prone to repairs.

Press collars

Press collars with adaptor jaw ZB202/203

- Suitable for ACO203, ECO203, EFP203, ACO203XL
- Metal pipe systems:
 - 42 - 54 mm (M-Contour)
 - 42 - 108 mm (V-Contour)
 - 28 - 54 mm (HP-Contour)
- Plastic pipe systems:
 - 40 - 63 mm (TH-Contour)
 - 40 - 110 mm (U-Contour)



Press collars with adaptor jaw ZB221/222

- Suitable for ACO203XL
- Metal pipe systems: 64 - 108 mm



Press collars for ACO403

- Metal pipe systems: HP 76.1 - 108 mm
- 114.3 - 168.3 mm



With different adaptor jaws, Novopress press collars can be pressed with the 203 units and the ECO301.

Especially for high-pressure applications, such as sprinkler systems, the ACO403 can be used to press special collars in the dimensions HP76.1 - 108 mm as well as in the dimensions 114.3, 139.7 and 168.3 for drinking water installations.



The overview below shows the compatibility of the press collars and adapter jaws with each other.

You can find further combinations in a detailed overview in the "Products" section at www.novopress.com.

Press collar		Device type 2			Device type 2XL	
		ZB201	ZB202	ZB203	ZB221	ZB222
M-Contour	M42, M54, M65 Copper only (Australia), M66.7 Mapress	✓	-	✓	-	-
	M64, M66.7 (X-Press), M67	-	-	-	✓	-
	M76.1 - M88.9	-	-	-	✓	-
	M108.0	-	-	-	✓	✓
HP-Contour	HP28, HP35	✓	-	✓	-	-
	HP42, HP54	-	-	✓	-	-
V-Contour	V42, V54	✓	-	✓	-	-
	V65, V80, V100 (Australia)	✓	-	✓	-	-
	V64 - V108.0	-	✓	-	-	-
TH-Contour	TH40, TH50, TH63	✓	-	✓	-	-
U-Contour	U40, U50, U63	✓	-	✓	-	-
	U75, U90, U110	-	✓	-	-	-

Accessories

Pivoting rings

The new flexibility

- For metal systems up to dimension 35 mm and plastic systems up to 32 mm for different profiles (M-/V-/TH-profile)
- Especially suitable for narrow, angled installation areas which are difficult to access
- Small dimensions, stepless rotating adaptor jaw
- Usable with ACO103, all 203 pressing tools (ACO203/ECO203 etc.) and their predecessors



Metal up to 35 mm
Plastic up to 32 mm



Easy handling due to
“snap on” principle



Rotatable up to 180°

The pivoting rings are used with an adapter jaw that allows the press rings to be pivoted at the maximum angle, making them much easier to use in installation spaces that are very difficult to access, narrow or angled.

The stepless positioning of the adapter jaw on the press ring on the fitting is particularly advantageous for one-hand operation.



Pivoting rings with adaptor jaw SZB101

- Suitable for ACO103
- Metal pipe systems: 15 – 35 mm
- Plastic pipe systems: 16 – 32 mm



Pivoting rings with adaptor jaw SZB201

- Suitable for ACO203, ECO203, EFP203, ACO203XL
- Metal pipe systems: 15 – 35 mm
- Plastic pipe systems: 16 – 32 mm



Compatibility pivoting rings

		Adaptor jaw device type 1 SZB101	Adaptor jaw device type 2 SZB201
M-Contour	M15, M18, M22, M28, M35	✓	✓
V-Contour	V15, V18, V22, V28, V35	✓	✓
TH-Contour	TH16, TH20, TH26, TH32	✓	✓



Our service pays off for you

Our service pays off for you

- **International service network** - in many countries around the world our regularly trained qualified service partners are at your disposal
- **Mobile on-site service** thanks to our service vehicle in Germany and parts of Europe
- **Extended warranty**
(see www.novopress.com for further information)

Our authorized service partners and certainly our own service workshop in Neuss ensure steady and reliable operation of the press tools and high safety for your pressed joints.

For more information about our services or the timetable of our mobile service truck, please do not hesitate to contact us by phone **+49(0)2131-288-916**.

A list of our established service partners can be downloaded on our website

www.novopress.com



I'LL CHECK THAT ✓



Easy to press – easy to check!

The NovoCheck App shows whether pressing was successful after the pressing process, mobile and directly on site on the tablet or smartphone. So you can be sure that everything has worked out!

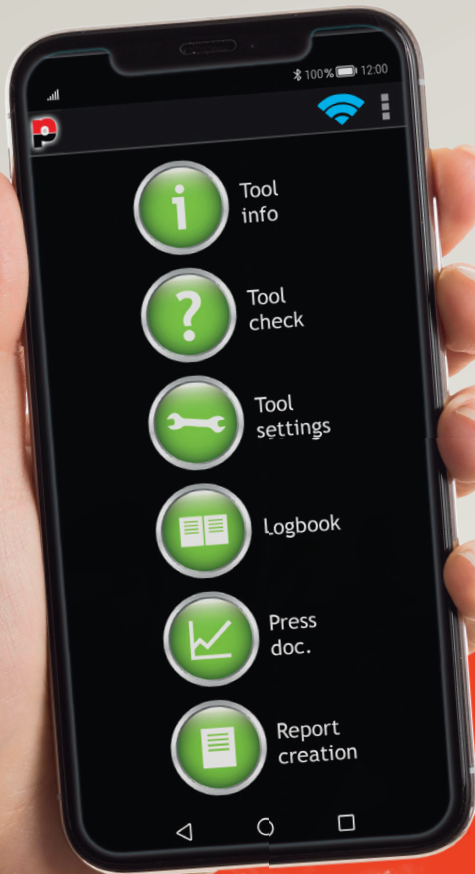

Press tools | Neuss | **novopress**
because quality matters

We reserve the right to make technical modifications.
The Bluetooth® word mark and logos are registered trademarks owned by Bluetooth SIG, Inc. and any use of such marks by Novopress is under license.



For more information,
please visit our website!

novopress

Novopress GmbH Pressen und Presswerkzeuge & Co. KG
Scharnhorststraße 1 · 41460 Neuss · Germany
Tel.: +49(0)2131-288-0 · Fax: +49(0)2131-288-155
www.novopress.com · E-Mail: verkauf@novopress.de